



COLOUR TELEVISION

INSTRUCTIONS

Thank you for buying this JVC colour television.
To make sure you understand how to use your new TV, please read this manual thoroughly before you begin.

AV-21L91
AV-25L91
AV-29L91



Contents

Safety precautions	2
Preparation	2
1 Insert the batteries into the remote control ...	2
2 Connecting the aerial and VCR	3
3 Connecting other devices	4
4 Connect the power cord to the AC outlet ...	4
5 Initial setting	5
Basic operation	6
Remote control buttons and functions	7
ECO SENSOR button	7
PICTURE MODE button	7
COLOUR SYSTEM button	7
SOUND SYSTEM button	7
⓪⓪I/II button	9
MUTING button	8
DISPLAY button	8
OFF TIMER button	8
RETURN + button	9
CHANNEL SCAN button	9
Using the TV's menus	10
Basic operation	10
INPUT	11
PICTURE TILT	11
VNR	11
COMPRESS (16:9)	11
AUTO SHUTOFF	12
CHILD LOCK	12
BLUE BACK	12
VIDEO-2 SET	13
Picture Adjustments	13
Sound Adjustments	13
AI VOLUME	14
AUTO CH PRESET	14
MANUAL CH PRESET	15
SKIP	16
LANGUAGE	16
TV buttons and parts	17
Using the buttons on the TV	18
Troubleshooting	19
Specifications	Back cover



Safety precautions

WARNING

- To prevent fire or shock hazard, do not expose the TV to rain or moisture.

CAUTION

- Operate only from the power source indicated on the rear of the TV.
- Avoid damaging the power cord and mains plug. When you unplug the TV, pull it out by the mains plug. Do not pull on the power cord.
- Never block or cover the cabinet openings for ventilation. Never install the TV where good ventilation is unattainable. When installing this TV, leave spaces for ventilation around the TV more than the minimum distances shown in the diagram.
- Do not allow objects or liquid into the cabinet openings.
- In the event of a fault, unplug the TV and call a service technician. Do not attempt to repair it by yourself or remove the rear cover.
- The surface of the TV screen is easily damaged. Be very careful with it when handling the TV. Should the TV screen become soiled, wipe it with a soft dry cloth. Never rub it forcefully. Never use any cleaner or detergent on it.
- When you don't use this TV for a long period of time, be sure to unplug it.

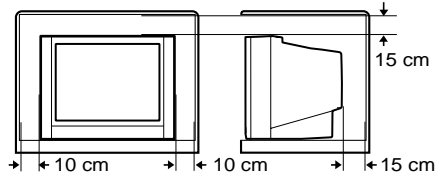

Preparation

1 Insert the batteries into the remote control

Correctly insert two batteries, observing the **+** and **-** polarities and inserting the **+** end first.

CAUTION:

Follow the cautions printed on the batteries.

Notes:

- Use AA/R6/UM-3 dry cell batteries.
- If the remote control does not work properly, fit new batteries.
The supplied batteries are for testing, not regular use.

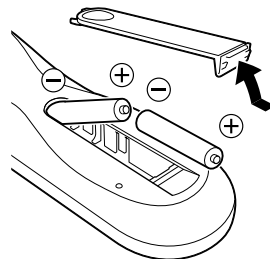

2 Connecting the aerial and VCR

- Read the manuals provided with the devices. Depending on the device, the connection method may be different from the diagrams. Also the device settings may need to change depending on the connection method.
- Turn off all the devices including the TV.
- Connecting cables are not supplied.
- When connecting monaural audio to the TV, use the L/MONO jack.
- If you connect the VCR to the TV only with an aerial cable, you should preset the video channel from the VCR to the AV channel (channel number 0) on this TV. See “MANUAL CH PRESET” on page 15 and preset it manually.

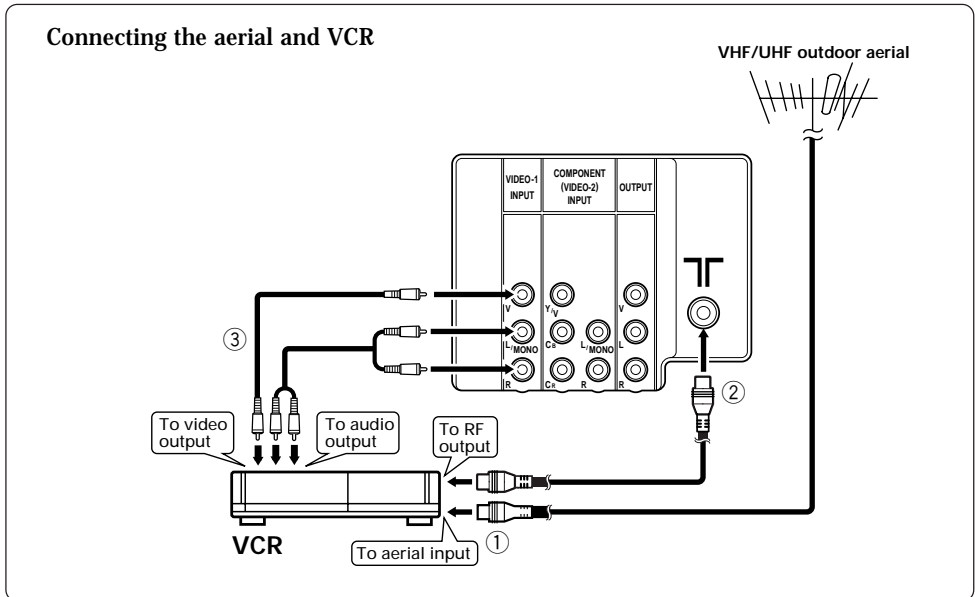
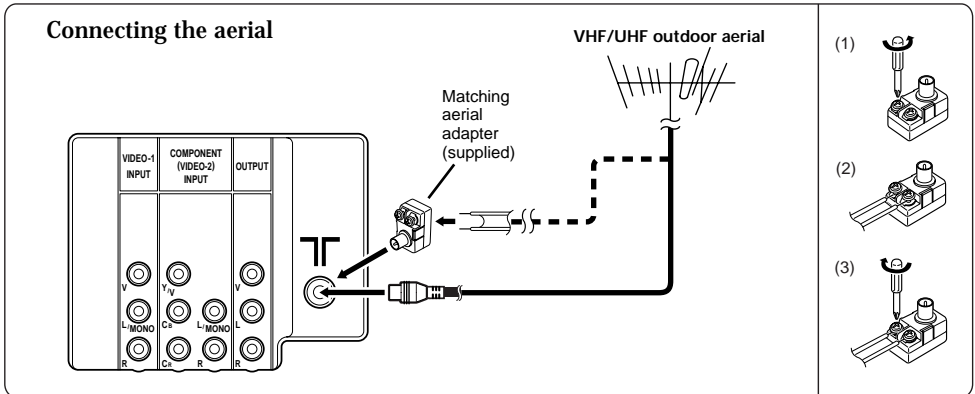

3 Connecting other devices

If you are not connecting any other devices, skip step 3 and perform step 4.

- Use the headphones with a stereo mini jack (3.5 mm in diameter). When you connect the headphones, the TV speakers go off.
- The OUTPUT terminal outputs the video and sound signals which you are viewing on the TV. You can dub them onto the VCR connected to the OUTPUT terminal. (The OUTPUT terminal cannot output component video signals. Also it cannot output any signals when the TV is turned off.)
- Connect components outputting a component signal (Y/Cb/Cr signal), such as a DVD player, to the VIDEO-2 terminal, and set VIDEO-2 SET function to “COMPONENT”. (See page 13.)
- The following illustrations are for the AV-29L91. Your TV’s front and rear pannels may not look exactly like the illustrations.

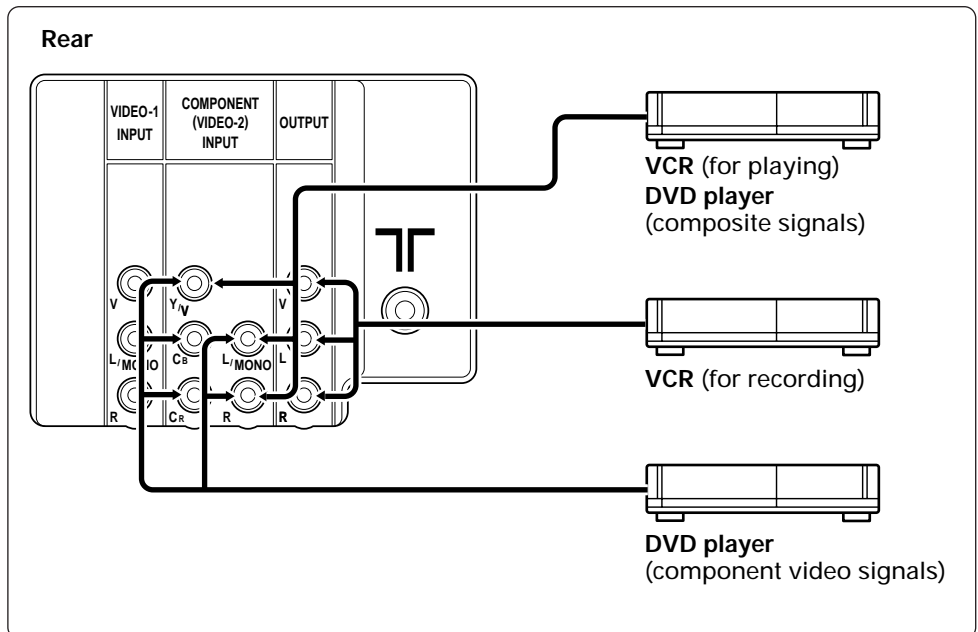
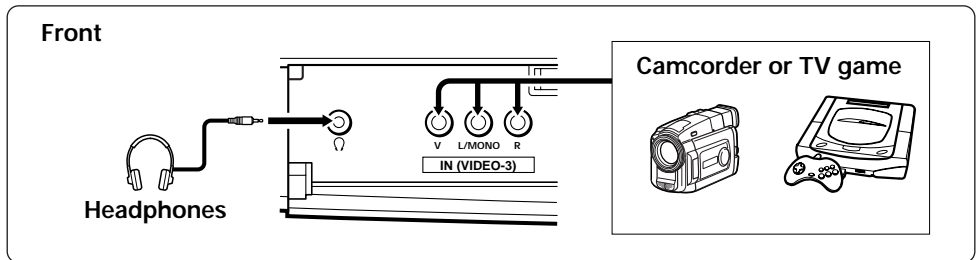

4 Connect the power cord to the AC outlet

5 Initial setting

When the TV is first turned on, it enters the initial setting mode, and the JVC logo is displayed. Follow the instructions on the on-screen display to perform the initial settings.

1 Press the Main power button on the TV.

The POWER lamp lights. After the JVC logo has been displayed, the TV automatically switches to the language setting mode.

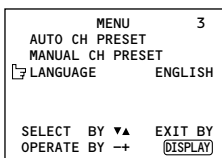

- The JVC logo does not appear if your TV has been turned on once before. In this case, use the LANGUAGE and AUTO CH PRESET functions to perform the initial settings. For details, see pages 14 and 16.

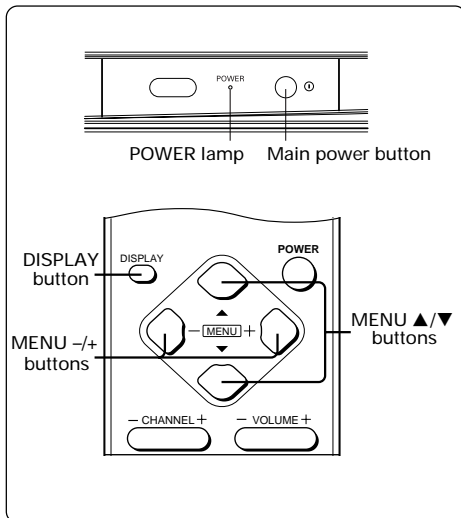

2 Press the MENU -/+ buttons to select language.

3 Press the MENU ▲/▼ buttons to select "AUTO CH PRESET"

4 Press the MENU -/+ buttons to start the AUTO CH PRESET function.

">>> ON SEARCH" is displayed on the screen.

When all the TV channels that can be received on your TV have been preset, the display goes out and the AUTO CH PRESET function operation is completed.

To stop the AUTO CH PRESET function, press the MENU -/+ buttons.

- If a TV channel you want to view is not set to the channel, set it with the MANUAL CH PRESET function. For details, see page 15.

This completes initial setting.

Now you're ready to enjoy your JVC TV.

Basic operation

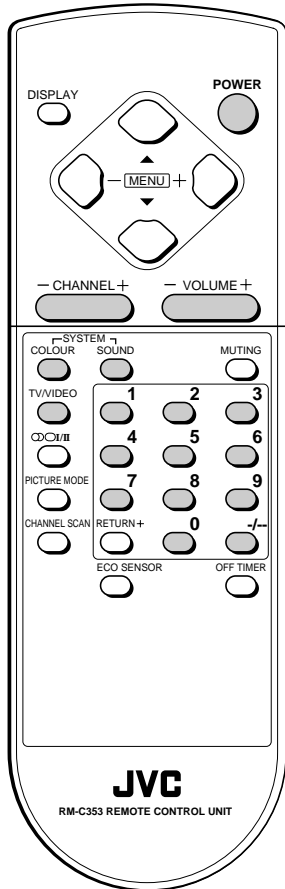

1 Press the **POWER** button to turn your TV on.

- If your TV does not turn on, press the Main power button on the TV then press the **POWER** button again.
- You can also turn on your TV by pressing any of the following buttons;
 - the **CHANNEL +/-** button
 - the **Number** buttons
 - the **TV/VIDEO** button

2 Select a channel.

- Press the **CHANNEL +/-** button.
 - Up/down selection cannot be selected for channels to which the **SKIP** has been set to "YES". See page 16.
- Press the **Number** buttons to enter the channel number.
 - If you want to enter a two-digit number, press the **-/--** button to select the two digit mode "--", then enter the channel number.

3 Press the **VOLUME +/-** button to adjust the sound.

4 To turn your TV off, press the **POWER** button.

- We recommend that you press the Main power button on the TV to turn the main power off if you do not plan to use your TV for a long time or if you wish to save energy.

If the picture is not clear:

Press the **COLOUR SYSTEM** button to select another colour system, see page 7.

If the sound is not clear:

Press the **SOUND SYSTEM** button to select another sound system, see page 7.

Viewing Images from an External Device:

Press the **TV/VIDEO** button to select the **VIDEO** mode.

- You can also use the **INPUT** function to select the **VIDEO** mode. For details, refer to page 11.

Remote control buttons and functions

ECO SENSOR button

You can adjust this TV so that the screen automatically adjusts to the optimum contrast according to the brightness of your room. This function reduces eye strain and the power consumption of this TV.

Press this button to select the desired mode.

DIGITAL ECO SENSOR DISPLAY:

The ECO SENSOR function switches on. In this mode, the clover mark indicating the brightness of your room is displayed for several seconds each time the brightness changes. The number of clover marks displayed on screen increases as your room becomes darker.

DIGITAL ECO SENSOR:

The ECO SENSOR function switches on. However, in this mode, the clover mark will not be displayed.

DIGITAL ECO SENSOR OFF:

The ECO SENSOR function switches off.

PICTURE MODE button

You can select one of three picture adjustment settings as you like.

Press this button to select a mode.

BRIGHT:

Heightens contrast and sharpness.

STANDARD:

Standardizes picture adjustments.

SOFT:

Softens contrast and sharpness.

- Pressing this button returns all the picture settings in "MENU 4" to their default settings.

COLOUR SYSTEM button

If the picture is not clear or no colour appears, change the current colour system to another colour system.

Press this button to select the colour system.

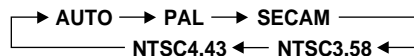

AUTO:

Automatic colour system selection.

- For the colour systems in each country or region, see the table "Broadcasting systems" on page 20.
- If the picture is not normal in the AUTO mode, change the AUTO mode to another colour system.

SOUND SYSTEM button

If the sound is not clear even when the picture appears normal, change the current sound system to another sound system.

Press this button to select the sound system.

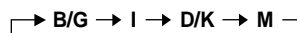

- For the sound systems in each country or region, see the table "Broadcasting systems" on page 20.
- You cannot select any sound system when in a VIDEO mode.

⊞⊞/II button

You can select a sound setting for stereo broadcast programmes and bilingual programmes.

Press this button to select a sound setting.

- ⊞⊞ : Stereo sound
- I : Bilingual I (sub I) sound
- II : Bilingual II (sub II) sound
- : Monaural sound

MONO: Cancels the multi-sound function, and the sound becomes monaural.

- If you have poor reception of a stereo broadcast, you can change from stereo sound (⊞⊞) to monaural sound (○) so that you can hear the broadcast more clearly and easily.
- If the multi-sound function cannot work normally due to poor signal quality, noise may be included in the sound, or the sound may change many times. If this happens, change the sound setting to MONO mode to cancel the multi-sound function.

MUTING button

You can turn the sound off instantly.

Press this button.

To turn the sound on, press this button again.

DISPLAY button

You can continuously display the current channel number or VIDEO mode on the screen.

Press this button.

To turn the display off, press this button again.

- When selecting a VIDEO mode with no signal, indication of the VIDEO mode becomes fixed on the screen.

OFF TIMER button

You can set the TV to automatically turn off after a set time.

Press this button to select the period of time.

- You can set the period of time to a maximum of 120 minutes in 10 minute increments.
- 1 minute before the OFF TIMER function turns off the TV, "GOOD NIGHT!" appears.

To display the remaining time, press this button once.

To cancel the OFF TIMER function, press this button to set the period of time to 0.

- The OFF TIMER function will not turn off the TV's main power.

RETURN + button

You can set a channel you frequently view to the Return Channel and you can view that channel at any time with one-touch.

To set the channel to the Return Channel:

- 1 Select the channel you want to set to the Return Channel.
- 2 Press this button and hold until the message "RETURN PLUS PROGRAMMED!" appears.
 - When you turn off the TV, the Return Channel setting is cancelled.

To view the Return Channel:
Press this button.

- You can view two channels (current channel and Return Channel) alternately by pressing this button.

To cancel the Return Channel setting:
Press this button and hold until the message "RETURN PLUS CANCELLED!" appears.

If no channel is set to the Return Channel:

You can view the channel selected right before the current channel by pressing this button.

CHANNEL SCAN button

You can quickly view all TV channels programmes that you can view on your TV, and search for the programme you want to view.

- 1 Press this button to start scanning TV channels.

The TV channel programmes are each displayed for several seconds.

 - The programmes of TV channels for which the SKIP function is set to "YES" are not displayed.
- 2 When you find the programme you want to view, press this button again to stop scanning.

Using the TV's menus

This TV has a number of functions you can operate using the menu. To use all your TV's functions fully, you need to understand how to use the menus.

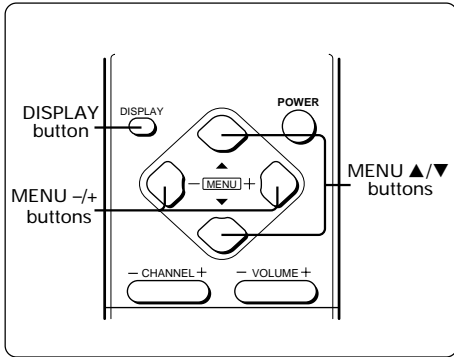

4 Press the MENU +/- buttons to change function settings.

Example:

Changes the AUTO SHUTOFF setting.

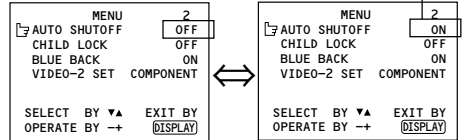

- With some functions, the operation method may differ.

■ Basic operation

1 Press the MENU ▲/▼ buttons.
One of the 5 menus is displayed.

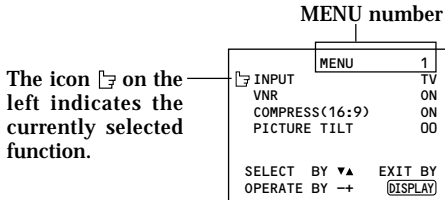

2 Repeatedly press the MENU ▲/▼ buttons to display a desired menu.

- If you hold down the ▼ button, the next menu is displayed.
- If the selected function is on the first line, pressing the ▲ button displays the preceding menu.

3 Repeatedly press the MENU ▲/▼ buttons to select a desired function.

5 Press the DISPLAY button to turn the display off.

- To operate a menu using the buttons on the front panel of the TV, refer to "Operating menus" on page 18.

INPUT

You can view images from VCRs or other devices connected to your TV.

- 1 Press **MENU ▲/▼** to display the "MENU 1" menu, then select "INPUT".

MENU	1
INPUT	TV
VNR	ON
COMPRESS(16:9)	ON
PICTURE TILT	00
SELECT BY ▼▲ EXIT BY	
OPERATE BY →← [DISPLAY]	

- 2 Press **MENU -/+** to select "VIDEO 1", "VIDEO 2" or "VIDEO 3".

TV mode changes to VIDEO mode.

PICTURE TILT

< AV-29L91 only >

There are cases where the Earth's magnetic force may make the picture tilt. If this happens, you can correct the picture tilt.

- 1 Press **MENU ▲/▼** to display the "MENU 1" menu, then select "PICTURE TILT".

MENU	1
INPUT	TV
VNR	ON
COMPRESS(16:9)	ON
PICTURE TILT	00
SELECT BY ▼▲ EXIT BY	
OPERATE BY →← [DISPLAY]	

- 2 Continue pressing **MENU -/+** until the picture becomes level.

VNR

You can reduce picture noise.

- 1 Press **MENU ▲/▼** to display the "MENU 1" menu, then select "VNR".

MENU	1
INPUT	TV
VNR	ON
COMPRESS(16:9)	ON
PICTURE TILT	00
SELECT BY ▼▲ EXIT BY	
OPERATE BY →← [DISPLAY]	

- 2 Press **MENU -/+** to select "ON".
To cancel the VNR function, select "OFF".

COMPRESS (16:9)

This function converts a normal picture (4:3 aspect ratio) into a wide picture (16:9 aspect ratio).

Use for pictures with a 16:9 aspect ratio that have been squeezed into a normal picture (4:3 aspect ratio), to restore their original dimensions.

- 1 Press **MENU ▲/▼** to display the "MENU 1" menu, then select "COMPRESS (16:9)".

MENU	1
INPUT	TV
VNR	ON
COMPRESS(16:9)	ON
PICTURE TILT	00
SELECT BY ▼▲ EXIT BY	
OPERATE BY →← [DISPLAY]	

- 2 Press **MENU -/+** to select "ON".



To cancel the COMPRESS (16:9) function, select "OFF".

AUTO SHUTOFF

You can set your TV to turn off if no signals are received for about 15 minutes or longer after the end of a broadcast.

- 1 Press **MENU ▲/▼** to display the "MENU 2" menu, then select "AUTO SHUTOFF".

MENU	2
AUTO SHUTOFF	ON
CHILD LOCK	ON
BLUE BACK	ON
VIDEO-2 SET	COMPONENT
SELECT BY ▼▲ EXIT BY	
OPERATE BY → DISPLAY	

- 2 Press **MENU -/+** to select "ON".

To cancel the AUTO SHUTOFF function, select "OFF".

- The AUTO SHUTOFF function does not turn off the TV's main power.
- The AUTO SHUTOFF will not work for a VIDEO mode.

CHILD LOCK

You can disable the front control buttons of the TV.

When this function is set to "ON", the TV can be operated using only the remote control.

Use this function to prevent children from operating the TV without parental consent.

- 1 Press **MENU ▲/▼** to display the "MENU 2" menu, then select "CHILD LOCK".

MENU	2
AUTO SHUTOFF	ON
CHILD LOCK	ON
BLUE BACK	ON
VIDEO-2 SET	COMPONENT
SELECT BY ▼▲ EXIT BY	
OPERATE BY → DISPLAY	

- 2 Press **MENU -/+** to select "ON".

To cancel the CHILD LOCK function, select "OFF".

- The CHILD LOCK function is canceled when you turn the power off.

BLUE BACK

You can mute the sound and change the picture into a blue screen while no signals are received by the TV, or when the signals are unstable.

- 1 Press **MENU ▲/▼** to display the "MENU 2" menu, then select "BLUE BACK".

MENU	2
AUTO SHUTOFF	ON
CHILD LOCK	ON
BLUE BACK	ON
VIDEO-2 SET	COMPONENT
SELECT BY ▼▲ EXIT BY	
OPERATE BY → DISPLAY	

- 2 Press **MENU -/+** to select "ON".

To cancel the BLUE BACK function, select "OFF".

- To view a broadcast even when the reception signal is poor, set the BLUE BACK function to "OFF".
- Even when the BLUE BACK function is set to "OFF", the sound may not be audible.

VIDEO-2 SET

Set the VIDEO-2 SET correctly according to the video signal input from the external device connected to the VIDEO-2 terminal. If this setting is incorrect, images will not be displayed.

- 1 Press MENU ▲/▼ to display the "MENU 2" menu, then select "VIDEO-2 SET".

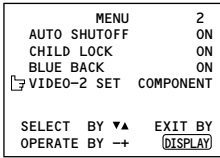

- 2 Set the VIDEO-2 SET according to the video signal input from the VIDEO-2 terminal.

If a normal video signal (composite video signal) is input:

Press the MENU -/+ buttons to select "VIDEO".

If a component video signal (Y/C_B/C_R signals) is input:

Press the MENU -/+ buttons to select "COMPONENT".

Picture Adjustments

You can adjust the picture as you like.

- 1 Press MENU ▲/▼ to display the "MENU 4" menu.

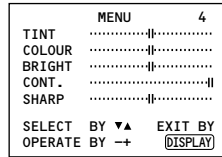

- 2 Press MENU ▲/▼ to select an item and press MENU -/+ to adjust it.

TINT* - : Reddish + : Greenish
COLOUR - : Lighter + : Deeper
BRIGHT - : Darker + : Brighter
CONT. - : Lower + : Higher
SHARP - : Softer + : Sharper

* TINT (tint) is displayed only when viewing images from NTSC3.58 or NTSC4.43 colour systems.

Sound Adjustments

You can adjust the sound as you like.

- 1 Press MENU ▲/▼ to display the "MENU 5" menu.

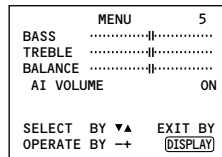

- 2 Press MENU ▲/▼ to select an item and press MENU -/+ to adjust it.

TREBLE - : Weaker + : Stronger
BASS - : Weaker + : Stronger
BALANCE - : Left + : Right

AI VOLUME

You can prevent the sudden increase or decrease of volume that occurs when changing channels or switching VIDEO modes.

- 1 Press MENU ▲/▼ to display the "MENU 5" menu, then select "AI VOLUME".

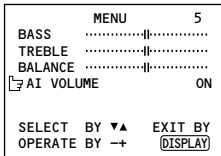

- 2 Press MENU -/+ to select "ON".
To cancel the AI VOLUME function, select "OFF".
- The AI VOLUME function may not operate as expected if the sound input level from a broadcast station (or video software) is extremely low.
 - The AI VOLUME function for TV mode and VIDEO mode can be set separately. For example, you can set it to be off in TV mode and on in VIDEO mode. If you set the AI VOLUME function while viewing a TV channel, the setting is registered as the setting for TV mode. If you set the AI VOLUME function while viewing images from a VIDEO terminal, the setting is registered as the setting for VIDEO mode.

AUTO CH PRESET

You can automatically preset all TV channels that can be received by your TV to channels.

- 1 Press MENU ▲/▼ to display the "MENU 3" menu, then select "AUTO CH PRESET".

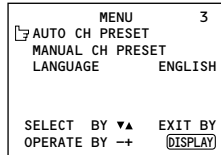

- 2 Press MENU -/+ to start the AUTO CH PRESET function.
">>> ON SEARCH" is displayed on the screen.
When all the TV channels that can be received on your TV have been preset, the display goes out and the AUTO CH PRESET function operation is completed.
To stop the AUTO CH PRESET:
Press the MENU -/+ button.
- The AUTO CH PRESET function does not preset a TV channel to the AV channel (channel number 0).
 - If the TV cannot preset the TV channel you want to view, preset it manually. For details, see "MANUAL CH PRESET" on page 15.

MANUAL CH PRESET

You can manually preset desired TV channels to desired channels.

- 1 Press MENU ▲/▼ to display the "MENU 3" menu, then select "MANUAL CH PRESET".

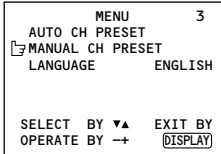

- 2 Press MENU -/+.

The sub-menu is displayed.

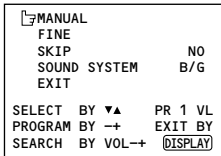

- The channel number is displayed as a PR number. For example, channel 1 will be displayed as PR 1. However, the AV channel will be displayed as AV.

- 3 Press MENU -/+ to select the channel number.

- 4 Press VOLUME -/+ to start searching for the TV channel.

">>>" or "<<<" is displayed on the screen.

When the TV finds a TV channel, the ">>>" or "<<<" display goes out, and the TV channel is preset to the currently selected channel number.

- If the TV channel you want to preset is not displayed, repeat step 4 until the TV finds the TV channel you want to preset.
- To stop the MANUAL CH PRESET function, press any button other than the VOLUME -/+ button.

If the picture is not clear:
Fine-tune the TV channel.

- 1 Press MENU ▲/▼ to select "FINE".

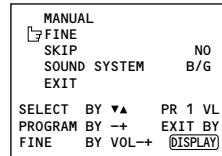

- 2 Hold VOLUME -/+ down to fine-tune the TV channel so that the best image is displayed on screen.

">" or "<" indicates that the TV is fine-tuning the TV channel.

If the sound is not clear:

- 1 Press MENU ▲/▼ to select "SOUND SYSTEM".

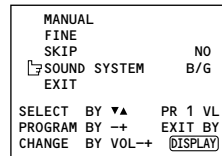

- 2 Press VOLUME -/+ to select the appropriate sound system.

- For the sound systems in each country or region, refer to the table "Broadcasting systems" on page 20.

- 5 Press MENU ▲/▼ to select "MANUAL".

- 6 Repeat steps 3 to 5 if you want to preset another TV channel to a channel.

SKIP

You can set undesired channels to be skipped. Channels set to be skipped cannot be selected by the CHANNEL $-/+$ buttons nor the CHANNEL SCAN button.

- Channels to which TV channels have not been preset are automatically set to be skipped.

1 Press MENU $\blacktriangle/\blacktriangledown$ to display the "MENU 3" menu, then select "MANUAL CH PRESET".

2 Press MENU $-/+$.

The sub-menu is displayed.

3 Press MENU $\blacktriangle/\blacktriangledown$ to select "SKIP".

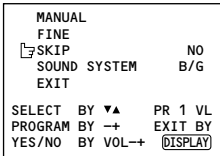

4 Press MENU $-/+$ to select the channel you want to skip.

5 Press VOLUME $-/+$ to select "YES".

The channel is set to be skipped.
To cancel the SKIP function, select "NO".

6 Repeat steps 4 and 5 if you want to set another channel to skip.

LANGUAGE

You can select the language for the on-screen display.

1 Press MENU $\blacktriangle/\blacktriangledown$ to display the "MENU 3" menu, then select "LANGUAGE".

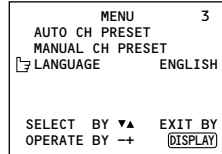

2 Press MENU $-/+$ to select language.

The on-screen display indications are in the selected language.

TV buttons and parts

Front

< AV-29L91 >

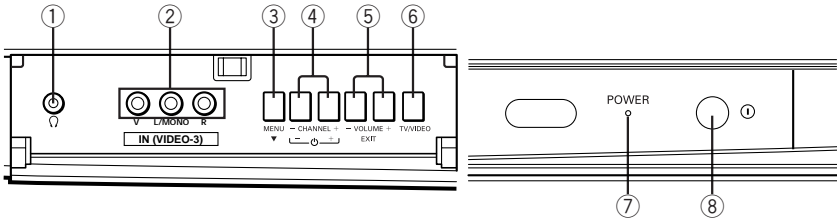

< AV-21L91 and AV-25L91 >

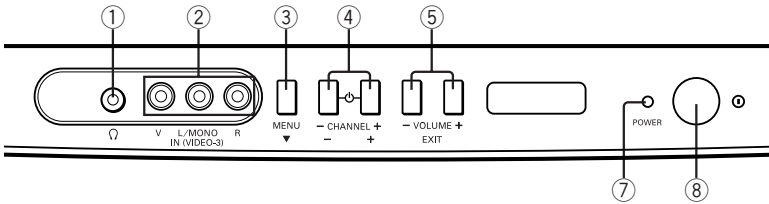

- ① Headphone jack
- ② VIDEO-3 terminal
- ③ MENU button
- ④ CHANNEL +/- buttons
- ⑤ VOLUME +/- buttons
- ⑥ TV/VIDEO button
- ⑦ POWER lamp
- ⑧ Main power button

Rear

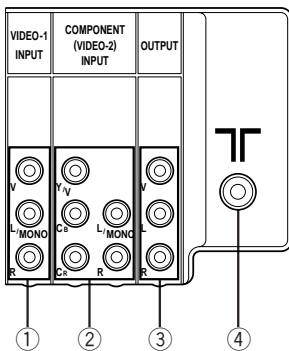

- ① VIDEO-1 INPUT terminal
- ② COMPONENT (VIDEO-2) INPUT terminal
- ③ OUTPUT terminal
- ④ Aerial socket

Using the buttons on the TV

Basic operation

- Check to make sure the CHILD LOCK function is set to “OFF”. When the CHILD LOCK function is set to “ON”, the TV cannot be operated using the front control buttons. For details, see “CHILD LOCK” on page 12.
- 1 Press CHANNEL $-/+$ to turn the TV on from standby mode.
 - 2 Press CHANNEL $-/+$ to select a channel.
 - 3 Press VOLUME $-/+$ to adjust the volume.
 - 4 To turn your TV off, press the Main power button to turn off the TV's main power.

To change the TV mode to the VIDEO mode:

- Press the TV/VIDEO button if the TV has one. See page 6.
- If the TV has no TV/VIDEO button, select the VIDEO mode with the INPUT function in “MENU 1”.

Operating menus

You can operate functions in menus using the front control buttons on the TV.

- 1 Press MENU \blacktriangledown to display a menu.
- 2 Press MENU \blacktriangledown repeatedly to display the menu you want to use.
- 3 Press MENU \blacktriangledown to select the desired function or item.
- 4 Press MENU $-/+$ or VOLUME $-/+$ to carry out the desired operation.
For details, see the description for each function.
- 5 Press VOLUME $-/+$ to turn the menu display off.

To turn the sub-menu display off:

- 1 Press MENU \blacktriangledown to select “EXIT”.

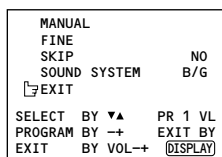

- 2 Press VOLUME $-/+$ to turn the display off.

Troubleshooting

If there is no picture or the TV does not operate normally, make sure the problem isn't due to the reasons indicated below.

If the problem persists even after taking the measures indicated, please contact a service technician.

Cannot turn the TV on

- Press the Main power button on the TV.
- Connect the power cord to the AC outlet.

The screen turns blue

- Is the BLUE BACK function on? (see page 12.)

Remote control inoperable

- Replace the batteries. (see page 2.)

Buttons on front of the TV do not work

- Switch the CHILD LOCK function off. (see page 12.)

TV does not respond immediately

- Press the main power button on the TV to turn off the main power. Press the main power button again to turn on the TV. If the TV returns to a normal state, operation is normal.

The TV turns off suddenly

- Is the OFF TIMER function set to operate? (see page 8.)
- Is the AUTO SHUTOFF function on? (see page 12.)

Poor sound

- Press the SOUND SYSTEM button to select another sound system. (see page 7.)
- Adjust the sound settings. (see page 13.)
- If there is noise during mono sound output, press the $\odot\circ/\text{II}$ button to select "MONO". (see page 8.)

Poor picture

- Press the COLOUR SYSTEM button to select another colour system. (see page 7.)
- Adjust the picture settings. (see page 13.)
- Is a component signal output device, such as a DVD player, connected correctly? (see page 4.)
- Is the "VIDEO-2 SET" function setting correct? (see page 13.)
- If noise (snow) totally blocks out the picture, check the following.
 - Have the TV and aerial been connected properly?
 - Has the aerial cable been damaged?
 - Is the aerial pointing in the right direction?
 - Is the aerial itself faulty?
- If the TV or aerial suffer interference from other equipment, stripes or noise may appear in the picture. Move any equipment which can cause interference away from the TV.
- If the TV or aerial suffer interference from signals reflecting from mountains or buildings, double-pictures (ghosting) will occur. Change the aerial's direction or replace it with an aerial with better directionality.
- When a white and bright still image (such as a white dress) is displayed on the screen, the white part may look as if it is coloured. When the image disappears from the screen, the unnatural colours will also disappear.

The picture is tilted

< AV-29L91 only >

- A picture may be tilted due to the influence of the earth's magnetism. In this case, use the PICTURE TILT function to adjust the tilt. (see page 11.)

Specifications

TV RF systems

B, G, I, D, K, K1, M

Colour systems

PAL, SECAM, NTSC 3.58 MHz, NTSC 4.43 MHz

Channel and frequencies

VHF low channel (VL), VHF high channel (VH), UHF channel (U)
 Receives cable channels in mid band, super band and hyper band.

External input / output

VIDEO-1: VIDEO input, AUDIO L/R input
 VIDEO-2/COMPONENT: VIDEO input, AUDIO L/R input,
 COMPONENT VIDEO (Y/CB/CR) input
 VIDEO-3: VIDEO input, AUDIO L/R input
 OUTPUT: VIDEO output , AUDIO L/R output
 Headphone jack: stereo mini jack (3.5 mm diameter)

Sound-multiplex systems

A2 or NICAM (B/G, I, DK)

Design and specifications subject to change without notice.

Broadcasting systems

Area	Country or Region	System	
		Colour	Sound
Asia, Middle East	Bahrain, Kuwait, Oman, Qatar, United Arab Emirates, Yemen, etc. Indonesia, Malaysia, Singapore, Thailand, India, etc.	PAL	B/G
	China, Vietnam, etc.	PAL	D/K
	Hong Kong, etc.	PAL	I
	Islamic Republic of Iran, Lebanon, Saudi Arabia, etc.	SECAM	B/G
	Philippines, Taiwan, Myanmar, etc.	NTSC	M
Europe	Russia, etc.	SECAM	D/K
	Czech Republic, Poland, etc.	PAL	D/K
	Germany, Holland, Belgium, etc.	PAL	B/G
	UK, etc.	PAL	I
Oceania	Australia, New Zealand, etc.	PAL	B/G
	Republic of South Africa, etc.	PAL	I
Africa	Nigeria, etc.	PAL	B/G
	Egypt, Morocco, etc.	SECAM	B/G